

STRENGTH ANALYSIS OF THE CONSTOR STEEL-CONCRETE CASK MODEL UNDER DYNAMIC TESTS

*G. Dreier (1), R. Diersch (1),
V. Nikitin(2), G. Pismennaya(2), V. Sokolov (2).*

(1) GNB Gesellschaft für Nuklear-Behälter mbH, Hollestr. 7 A, D-45127 Essen, Germany

(2) AOOT NPO CKTI, Politechnicheskaya 24, 194021 St.-Petersburg, Russia

SUMMARY

A drop test series has been performed with a 1:2 scale model of a CONSTOR-type steel-concrete cask (mass ~ 90 t) designed for transportation and storage of spent fuel of NPP. Characteristic points were selected on the outer and inner surfaces of the model where more than 30 strain gauges and accelerometers were mounted. Their indications (strain, acceleration) were recorded as continuous functions of time in the process of impact testing of the model.

Before the beginning of the tests the mechanical behaviour of the model under the drop test conditions was analysed taking into account all dynamic processes in the model. As a result time-functions of strain or acceleration were calculated for every point where strain gauges or accelerometers were mounted. The wave character of stress-strained state of the model in the process of impact was taken into account in forming the prediction.

By direct comparison of analysis and experimental results, the degree of reliability of analytical methods and admissibility of assumptions taken in cask designing and in demonstration of its safety under conditions of transportation and storage was checked.

INTRODUCTION

The CONSTOR is a Type B(U) package for transport and storage of spent fuel elements. With a 1:2 model of the CONSTOR a series of drop tests has been performed in order to validate the approaches used for the mechanical analyses of the cask. The test program was confirmed by GOSATOMNADSOR of the Russian Federation and by the German Federal Institute for Materials Research and Testing (BAM).

The drop test series was composed of four tests (A to D) according IAEA regulatory for type B(U) packages and two drop tests (E, F) simulating a hypothetical accident at the storage site:

- A) 9-m-drop horizontally onto the IAEA target,
- B) 1-m-drop horizontally onto an IAEA pin,
- C) 1-m-drop vertically bottomside onto an IAEA pin,
- D) 1-m-drop vertically lid side onto an IAEA pin,
- E) 1-m-drop without impact limiters vertically bottom side onto the IAEA target,
- F) 1-m-drop without impact limiters with bottom corner onto the IAEA target.

According to the test program, these drop tests have been analysed prior to the experiments. This article briefly describes the analytical method used and presents some results in comparison to the measurements. With regard to the most severe loading and taking into account the limited length of the paper, only drop tests A, B and E will be presented. A since the cask had the biggest drop height, B because the loading was more severe compared to the pin drops C and D and finally E as the more severe storage site simulation drop compared to F.

CONSTOR TEST CASK

The CONSTOR test cask is depicted in Figure 1. With a mass of more than 10 t, it is a copy of the original representing all main geometric parameters of the cask on a 1 : 2 scale, and it is made of the same material as the original.

The body consists of a steel-concrete-steel sandwich construction. The closure system is composed of a bolted primary lid, a welded intermediate lid and a welded secondary lid. The basket with the fuel elements was represented by an equivalent dummy mass. A special shock absorber made up of a ring of deformable steel ribs is located at the cask bottom. The purpose of this component is to cushion hypothetical drops during handling at the storage site. In the transportation configuration the cask is equipped with two wooden impact limiters, one at the bottom and one at the lid end.

Characteristic points were selected on the outer and inner surfaces of the model where more than 30 strain gauges and accelerometers were mounted. Their indications (strain, acceleration) were recorded as continuous function of time.

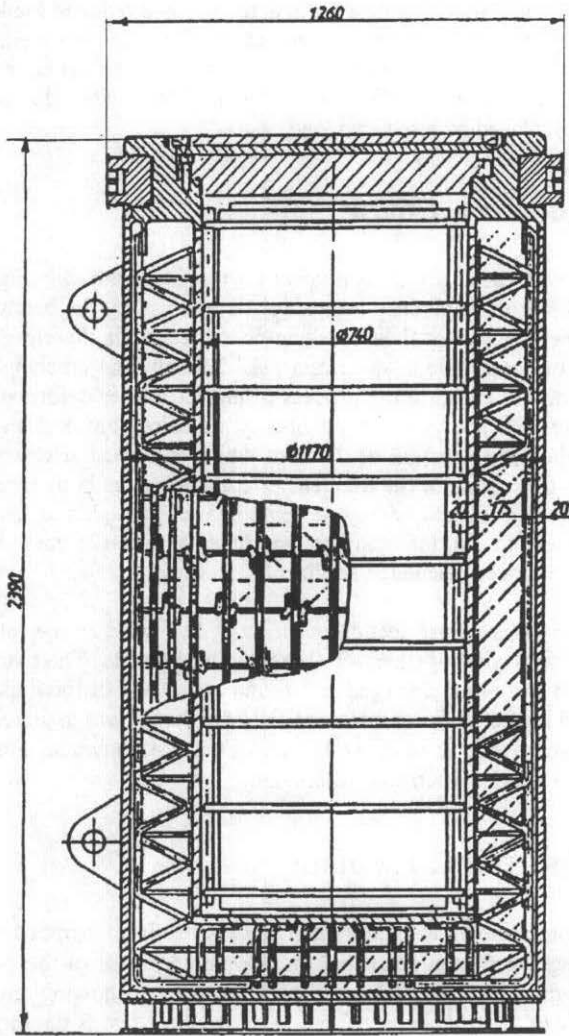

Figure 1:
CONSTOR 1:2 model

CALCULATIONAL APPROACH

The analysis of the CONSTOR drop tests were performed using analytical methods taking into account the wave character of the stress-strained state of the model.

Taking the impact limiter as a crushable member and the cask itself as a rigid body, the cinematic and dynamic components of the drop event (i.e., velocity, deceleration, reaction force, etc.) were calculated in a first step. The calculations of the CONSTOR cask strains are based on the theory of one-dimensional wave propagation described in scientific textbooks. The so called *method of characteristics* has been used to solve the one-dimensional wave propagation equation. The calculation of the lids of CONSTOR was done using the so called

reduction method reducing the lids to a mass-spring-system acted on by a reduced loading due to inertia (limiter loading) and due to elastic vibration of the cask. The reduction method was also used for the calculation of the 9-m horizontal drop. The cask body was treated as a beam loaded on its ends. The mass and the stiffness of the cask are replaced by a reduced mass and a reduced stiffness, the load being replaced by a reduced load.

RESULTS FOR THE 9 M HORIZONTAL DROP

The configuration of the impact with the active measurement devices is displayed in Figure 2a. The loading of the cask in the 9 m horizontal drop is strongly determined by the behaviour of the two impact limiters. A correct analysis of their crushing characteristic is therefore crucial for the subsequent calculations of accelerations and strains. Additionally the crushing of one trunnion coming into contact with the target in the process of impact limiter deformation has to be taken into account. Figure 2b shows the time history of calculated and measured accelerations at location B5 in the centre section of the cask which is highest stressed in this drop orientation. Comparing the magnitude of the frequencies controlling the body motion the calculation gives conservative results compared to the experiment. Though the calculated impact duration (15 ms) is somewhat shorter than the experimental one (25 ms) the load controlling impact characteristic has been calculated sufficiently accurate.

The highest bending strains occur in the centre section of the cask. In Figure 2c the calculated axial strains at location D5a are displayed together with the measured results. The two curves practically coincide in the first 15 ms. Some divergence is found at the end of the impact that may be explained by a more rigid impact of the trunnion on the base than it was assumed in the analysis. The corresponding compressive stresses at location D6a are shown in Figure 2d showing a good agreement between calculation and experiment.

RESULTS FOR THE 1 M HORIZONTAL PIN DROP

A sketch of the test configuration is shown in Figure 3a. The cask has been dropped without impact limiters and the drop height has been corrected for the missing mass of the package. The pin (diameter 75 mm, height 100 mm) was installed on a device allowing the direct measurement of the time history of the total impact force. As a result of test B the model has received a 3 mm deep local imprint in the area of direct contact with the pin surrounded by a zone of global deformation of the body with a max. depth of total 10 mm. The test has shown, that the outer steel liner was not penetrated by the pin. From all members the pin itself got the largest plastic deformation with a compression of 21 mm and a diameter increase of about 84 mm. The calculated values of liner deformation and pin compression are 13 mm and 20.5 mm respectively and meet the experimental values.

Figure 3b contains the calculated as well as the measured time history of the total impact force in the primary loading phase of 20 ms duration. Both curves show satisfactory agreement. Therefore the overall impact characteristic was calculated correctly. Accelerometer B4z located in the cask cavity above the impact area characterises the interaction of the cask body with the pin. Calculated and measured decelerations are shown in Figure 3c. The calculated curve passing over the peaks of the experimental one gives conservative results. The induced bending oscillations due to the concentrated pin-load are characterised by the strains in location D6a, shown in Figure 3d. Regarding amplitude and frequency behaviour the

calculated curve is in agreement with the experimental one showing that the overall bending behaviour was analysed correctly.

RESULTS FOR THE 1 M VERTICAL DROP WITHOUT IMPACT LIMITERS

The test cask is dropped without impact limiters from a height of 1 m in vertical position bottom down on the rigid target as sketched in Figure 4a. The impact is taken up by a 10 mm deformation of the vertical ribs of the support shock absorber fixed at the bottom end of the cask.

The loading of the cask body is characterised by the acceleration of location B1 shown in Figure 4b. The calculated deceleration value of about 270 g is in agreement with the measurement. High oscillations are induced into the lid system during the impact process. The decelerations of the secondary lid at location B2 are shown in Figure 4c. Acceleration peak values reach up to 600 g. The calculation clearly gives conservative results.

The bending oscillation of the secondary lid leads to strains in the welding seam at the lid perimeter. In location D1r these values have been quantified as shown in Figure 4d. The frequency of the bending is overestimated in the calculation but the amplitude of the bending oscillations fits quite well with the measurement.

CONCLUSIONS

The comparison of the pre-test analysis results with the corresponding experimental data, shows a satisfactory agreement for all investigated test orientations. Accordingly all relevant impact processes including

- the crushing of the wooden impact limiters as well as the trunnion in test A
- the deformation and corresponding force transmission of the pin in test B (test C and D) accordingly)
- the deformation and force generation of the support shock absorbers in test E (test F accordingly)

have been simulated sufficiently accurate.

The tested cask model itself survived six consecutive drop tests and maintained its integrity and leak tightness as confirmed by post test inspections proving that the CONSTOR is a suitable design for Type B(U) packages as well as for storage.

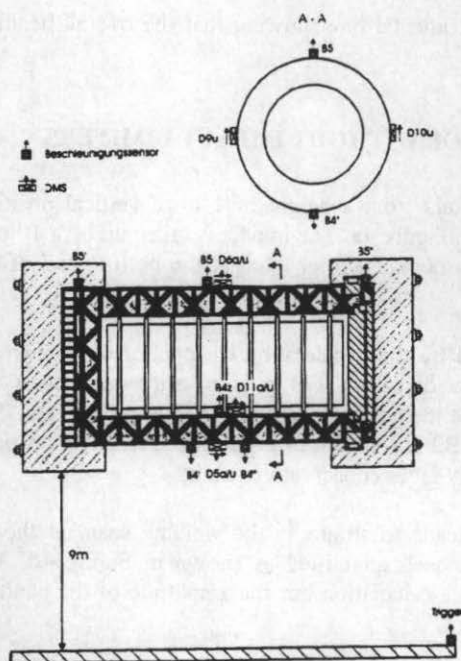
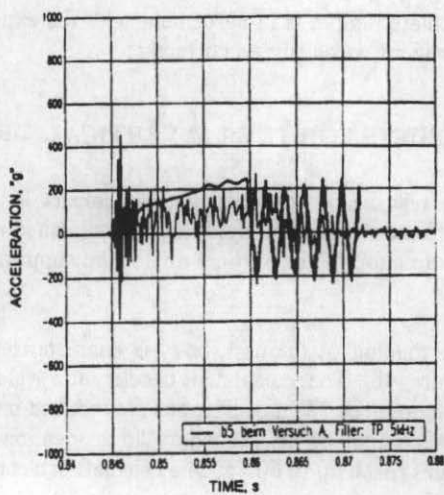
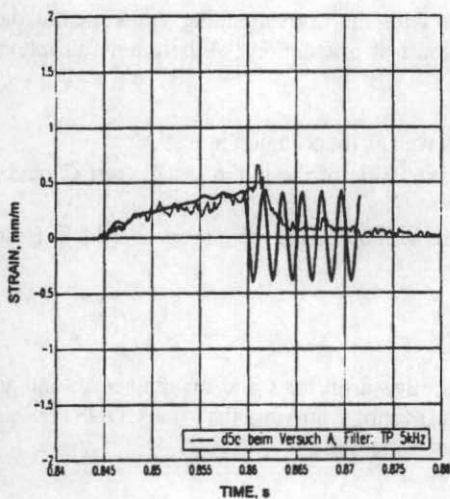

Figure 2a: Sketch of 9 m horizontal drop with measurement locations



— experiment
— calculation

Figure 2b: Acceleration at location B5



— experiment
— calculation

Figure 2c: Strain at location D5a

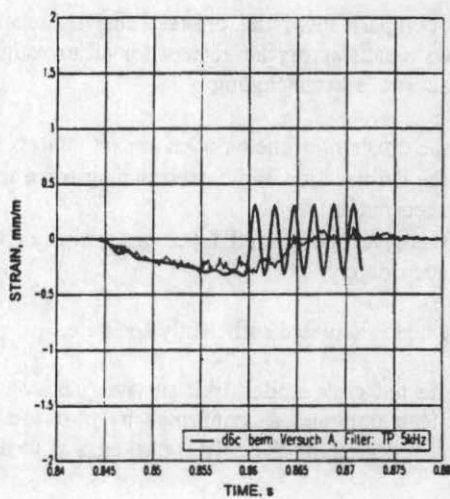

— experiment
— calculation

Figure 2d: Strain at location D6a

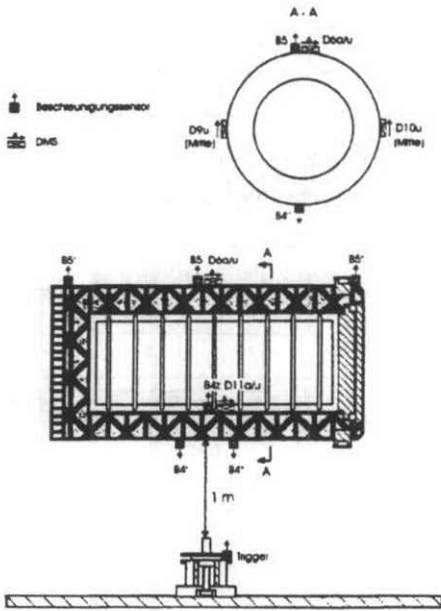

Figure 3a: Sketch of 1 m horizontal pin drop with measurement locations

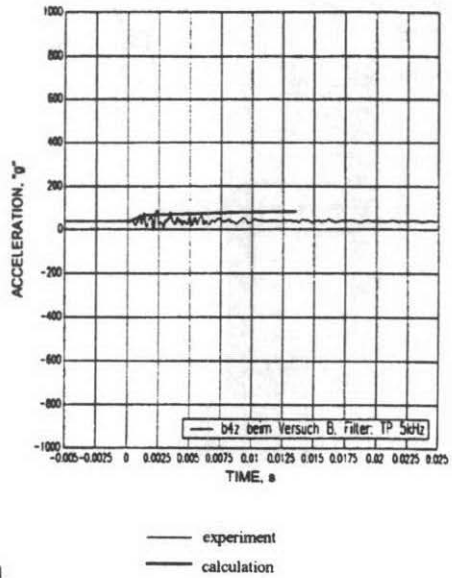

Figure 3c: Acceleration at location B4z

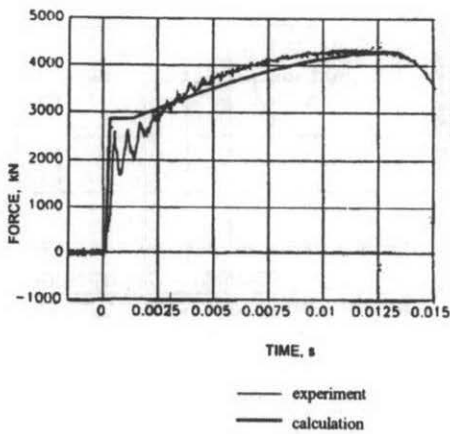

Figure 3b: Total impact force

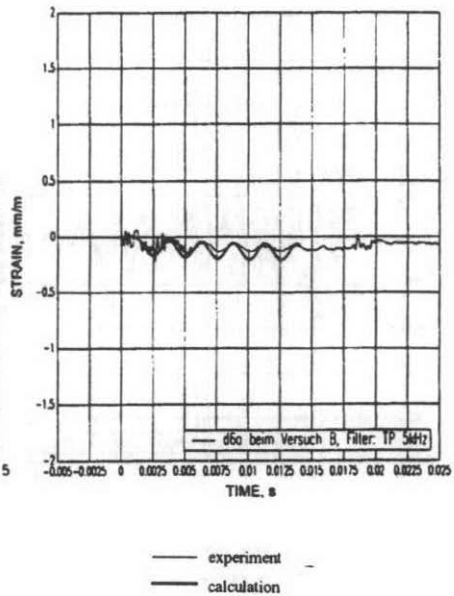

Figure 3d: Strain at location D6a

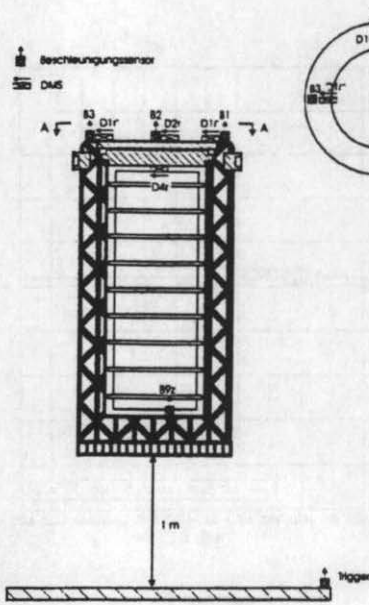

Figure 4a: Sketch of 1 m vertical drop with measurement locations

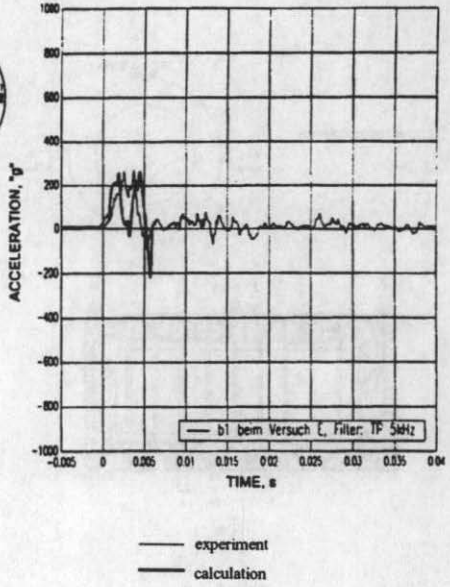

Figure 4b: Acceleration at location B1

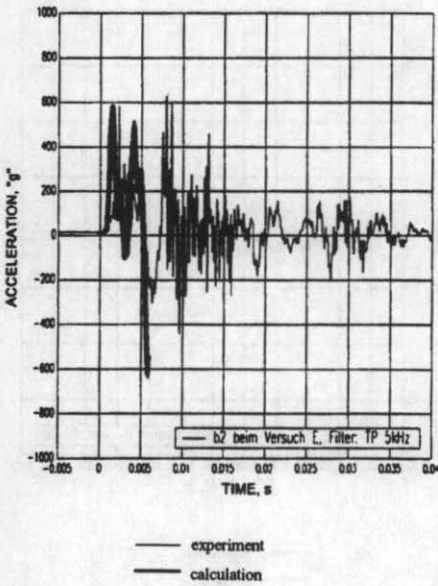

Figure 4c: Acceleration at location B2

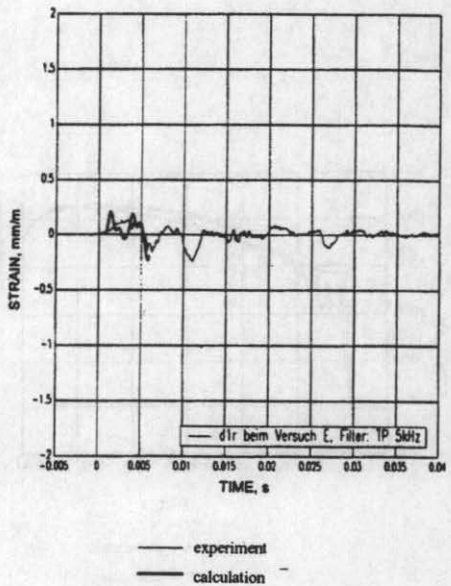

Figure 4d: Strain at location D1r